

Peeler/ Scrubber/ Washer – 1820

Continuous Washing & Peeling in
One Efficient, Flexible Machine



Vanmark's Peeler/Scrubber/Washers integrate the continuous washing and peeling of a variety of products into one machine. Whether you are only separating foreign material, scrubbing or removing skins entirely – the 1820 series combines high quality performance and durability with ease-of-use and efficiency for potato chip and produce processors. Product is tumbled through a configurable combination of four or six roller types, spray bars and other optional features, speed and settings – ensuring effective and flexible processing.

- Continuous washing, scrubbing and peeling in one machine – increasing efficiency in a compact footprint
- Standard flow rates up to 4,000 pounds per hour of storage potato capacity
- Configure roll types, options, speed and discharge gates to your exact operation
- EasyFlow™ Gate with screened chute and manual adjustable lever for easy operation and better load visibility
- Quick roll change and setting updates increase flexibility for multiple applications, with limited downtime
- Sanitary design with easy access peel chamber allows for quick and thorough cleaning

Common Food Applications

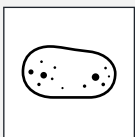

Potatoes

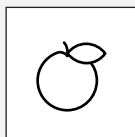

Apples

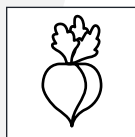

Beets

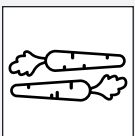

Carrots

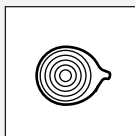

Onions

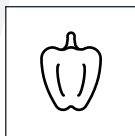

Peppers

Peeler/Scrubber/Washer – 1820

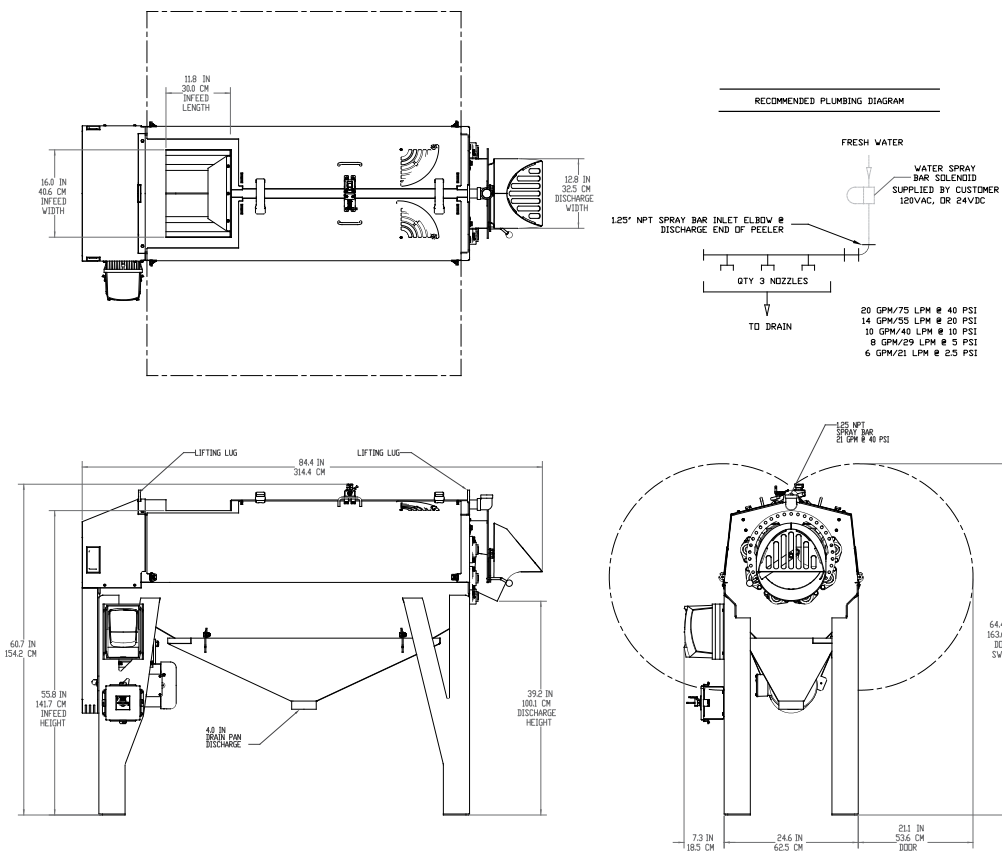

This drawing contains confidential information is the exclusive property of Vanmark Equipment, LLC. Neither this document, nor its contents, are to be used, reproduced or disclosed in whole or in part without the express written permission of Vanmark. Copyright 2017, Vanmark Equipment, LLC.

Specifications

Roll Speed: 100-550 RPM

Motor: 2 HP, 230-460 VAC, 3 Phase
(1 Phase available)

Weight: 1000 lbs. (454 kg)

Features

- Available with four or six rolls
- Available roll types: brushes and coated abrasive
- Multiple gate configurations available
- Includes trapped key door interlock system (24V or 120V)

Options

- Models: 1824 (four roll), 1826 (six roll)
- Options: drain pans, small product package, one-touch inverter control with lockable power switch
- Trapped key door interlock system deduct

E 12.18v4

Contact Us

Vanmark is proud to provide top quality equipment, exceptional service and peace of mind worldwide for the potato and produce processing industries. Contact us for more information and to custom-fit the Peeler/Scrubber/Washer – 1820 for your specific application.



To feed our growing world - Together

Phone: +1 740-201-0004

Email: sales@vanmark.com

vanmark.com